

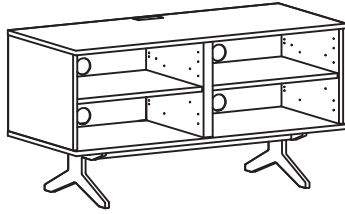

unnu Base 2 + 3

Version 1.1

unnu 221



unnu 231

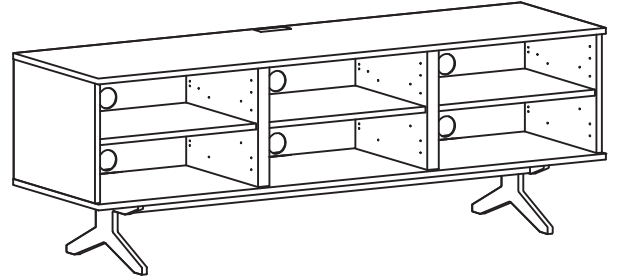

Beslag inkluderet
Fittings included
Besläge inbegripen

unnu 221

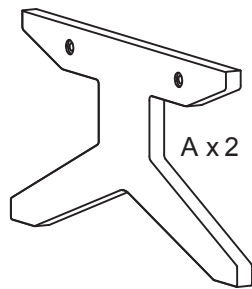

A x2



B x4

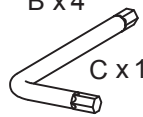

C x1



B x8

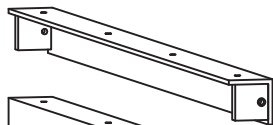

E x1

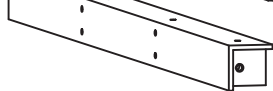

F x1

unnu 231

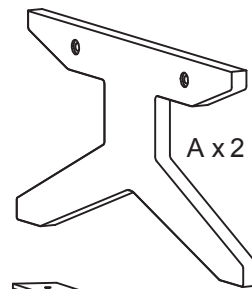

A x2



B x4



C x1



B x12

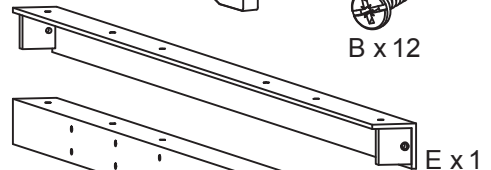

E x1



F x1

Nødvendigt værktøj
Tools needed
Benötigte Werkzeuge

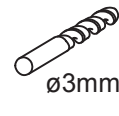
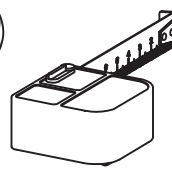
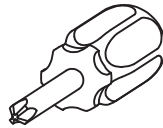
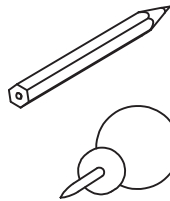

ø3mm

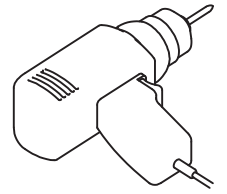

1

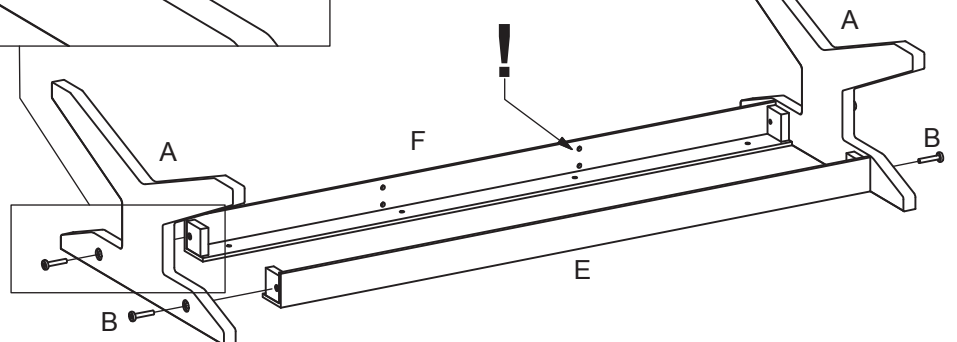
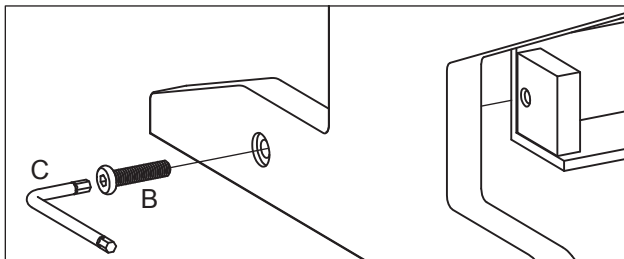

2



unnu 221



unnu 211 + 211

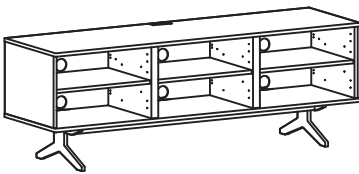
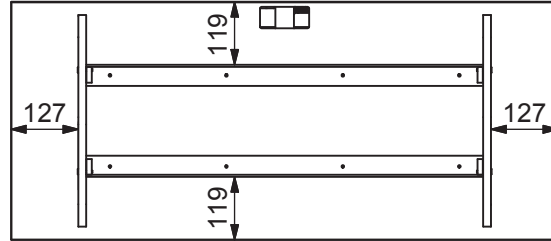

unnu 231

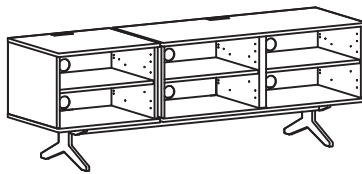

unnu 211 + 221

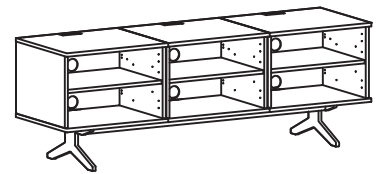

unnu 211 + 211 + 211

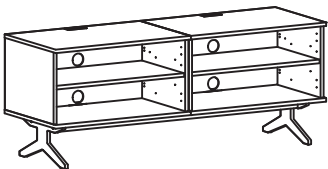
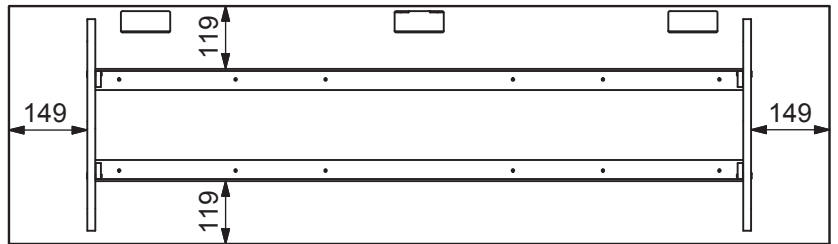

unnu 211 Large + 221 Large

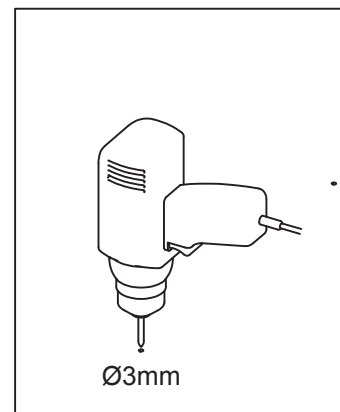
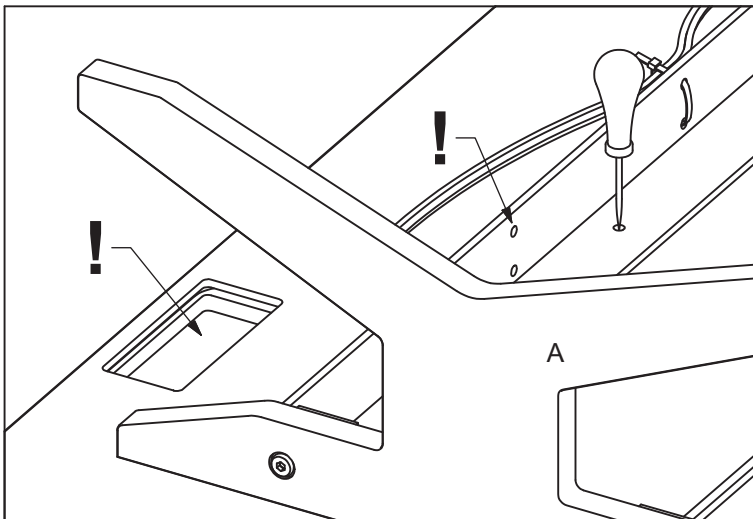
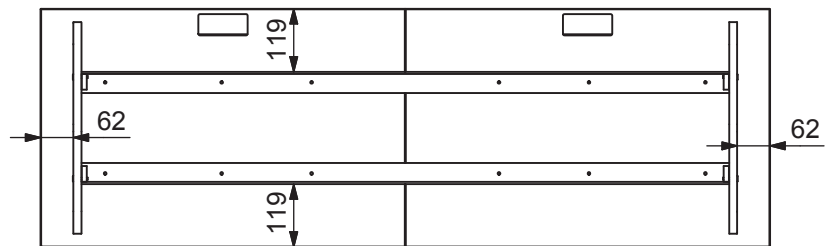

Maximalt 12mm dybe
Maximum Tiefe 12mm
Maximum depth 12mm

3

